

# *All Change*

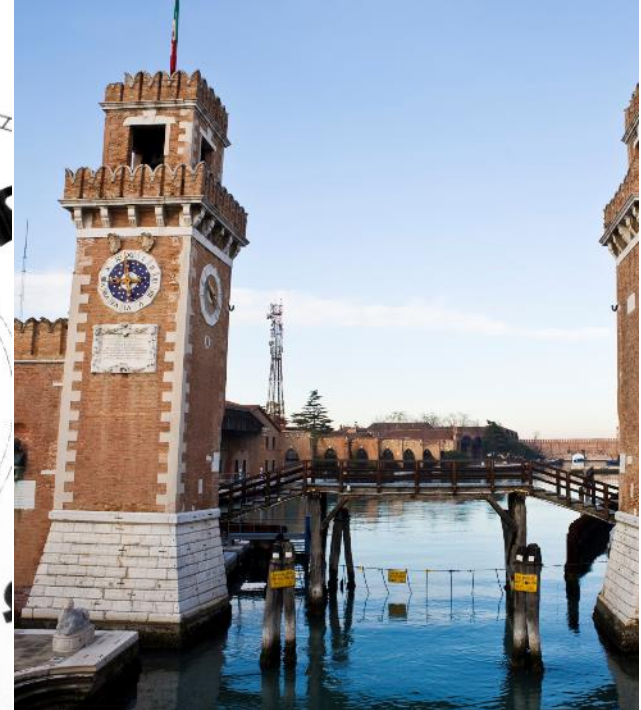

Mark Greenhouse - Levantar

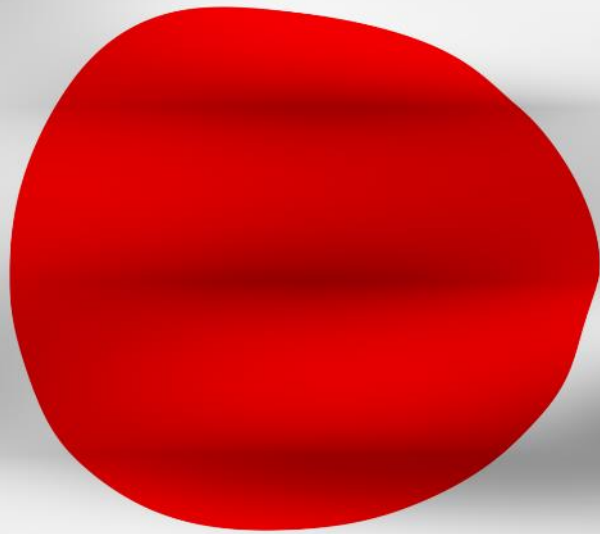



## Japan

- Time is Money – US 9\* more productive
- Improvement – Morris Garages, Self Service Supermarkets
- Venetian Arsenale

# “ALL CHANGE”

- Turn each coin individually, then move all ten to the next person.
- Things to measure;
  - 1<sup>st</sup> Coin through
  - Last Coin through
- **Audio, Visual, Kinaesthetic – 30%**
- **God Complex** – TED Tim Harford – “Trial and Error and the God Complex”
- Does this stop people, employees raising issues, challenges?

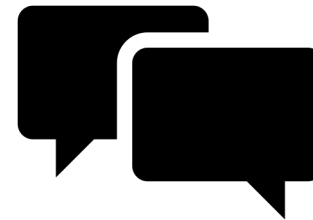

30%

**TED**

IDEAS WORTH SPREADING  
IDEAS WORTH SPREADING

# Results

	1 <sup>st</sup> Estimate	1 <sup>st</sup> Actual	2 <sup>nd</sup> Estimate	2 <sup>nd</sup> Actual	3 <sup>rd</sup> Estimate	3 <sup>rd</sup> Actual
1st Coin		61				7
All Coins		67				20

Results are the time in seconds it took to “process” the coins.

2<sup>nd</sup> Round is     x slower/faster than 1<sup>st</sup> Round

3<sup>rd</sup> Round is     8\* slower/faster than 1<sup>st</sup> Round

*Ideas to Improve the  
Flow...*



# 3 Versions of a Process

At Least Three Versions

What you think it is...

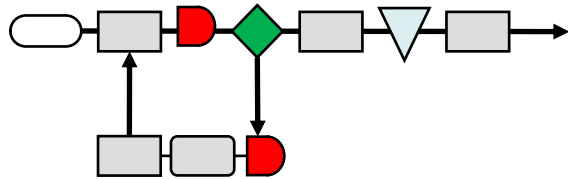

What it actually is...

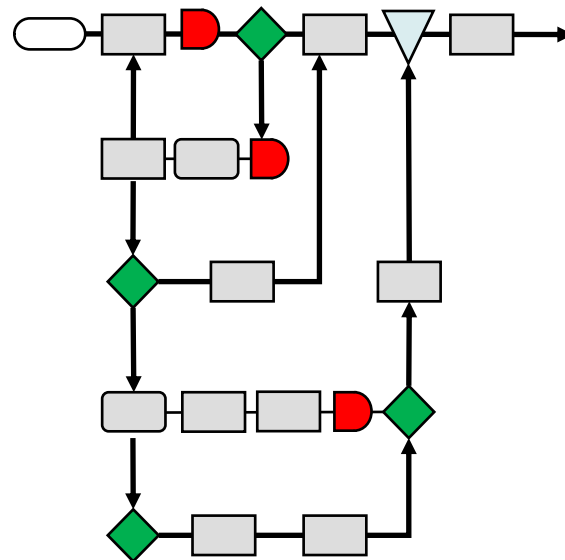

What you would like it to be...



Often a process is not what you think it is!

WHOOA!

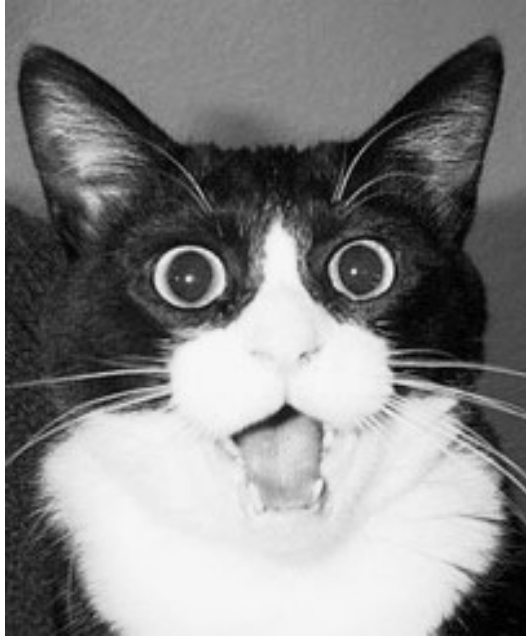

**What do you mean there's more than 1 version of the truth?**

# “Why Do You Do It That Way?”

- *“We’ve Always Done It This Way”* (Most Dangerous Phrase in Business)
- *“My Boss/Team Leader/Supervisor told me to do it this way...”*
- *“It’s the way I was taught..”* (often somewhere else)
- *“The software (process) means we have to do it this way...”*
- *“We’ve asked for it to be changed...”*
- *“We don’t normally, we have these visitors in...”*
- *“Is there another way?...”*



# *Ideas to Improve the Flow...*

- MOVE CLOSER together
- Put the COINS on a SHEET OF PAPER – MOVE THAT
- STACK THE COINS
- BUY COIN TURNING MACHINES
- ACHIEVE FLOW
- ASK THE CUSTOMER – 2p, 5p, 10p
- REMOVE the PEOPLE BETWEEN the TWO ENDS
- TRAINING
- WORK HARDER/FASTER – Check everything



# *Ideas to Improve the Flow...*

- **MOVE CLOSER together (Same)**
- Put the COINS on a SHEET OF PAPER – MOVE THAT (Ppl)
- STACK THE COINS (Ppl)
- BUY COIN TURNING MACHINES (Ppl)
- **ACHIEVE FLOW (Same)**
- **ASK THE CUSTOMER – 2p, 5p, 10p (really??)**
- REMOVE the PEOPLE BETWEEN the TWO ENDS (redundancy - once only)
- TRAINING (Ppl)
- WORK HARDER/FASTER – Check everything, MI, big stick (Ppl)



# “ALL CHANGE” - Results

- Speed is a minimum 5 \* faster
- Capacity is twice that of before
- They are *RELATED* not *LINKED*.
  - Depends on number of steps and process time.



# Lean Thinking - ~~7 Wastes~~

## FRUSTRATIONS

Waiting,

Rejects and Re-Work

Over Processing, Duplication

Motion

Inventory

Over Production

Transportation



## 7 DAILY FRUSTRATIONS

**STOP** throwing time and effort away!



FREE GUIDE ON FINDING  
"HIDDEN" WASTED TIME  
AND EFFORT IN LAW FIRMS.  
For a copy email;  
[mark@levantar.co.uk](mailto:mark@levantar.co.uk)

# Levantar - Management Value Stream Map ©

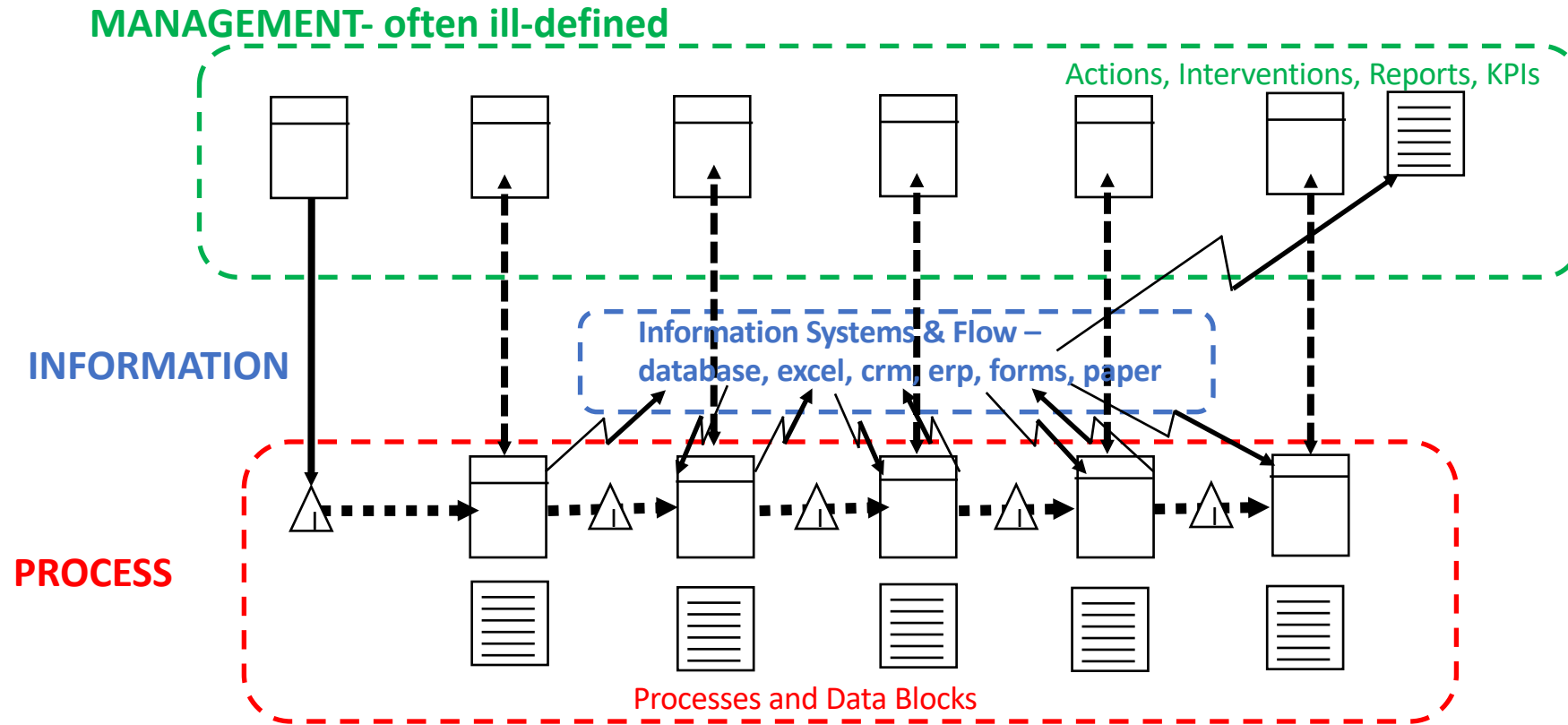

# What Might an Accountant Say?



10 Coin Turns + 1 Move is BETTER/CHEAPER than 10 Coin Turns + 10 Moves

# All Change

- **Observe** the work, the process, the flow – not just the activities. BEWARE GOD!
- Remove the time between the activities.
- Focusing on **“Flow”**
- There are 7 Daily Frustrations which delay work from **“Flow”**
- Change a process; change the management and behaviours, software?



Mark Greenhouse - Levantar  
[Mark@levantar.co.uk](mailto:Mark@levantar.co.uk)

